



88-98 CHEVY/GMC BOX BOARD

IN217
05/02/03

DRILLING INTO BODY AND FRAME IS REQUIRED.

INSTALLATION PARTS LIST	QTY.	DESCRIPTION	QTY.	DESCRIPTION
1	1	RUNNING BOARD	1	PASSENGER
2	2	STONE GUARD	10	5/16" x 3/4" BOLT
3	8	3/8" x 1 SELF TAPPING SCREW	8	5/16-18 HEX WASHER HEAD NUT
4	2	#14 x 3/4" SHEET METAL SCREW	2	FLAT BRACKET, FL74
5	2	1/4 x 5/8" SQUARE HEAD SCREW	2	FLAT BRACKET, FL73 D&P
6	2	1/4-20 HEX NUT	2	HORIZONTAL BRACKET, SUPPORT, 3124F
7	1	END CAP 1 LEFT & 1 RIGHT	2	#14 x 3/4 TEK SCREW

TOOLS REQUIRED: 5/16" DRILL • 1/2" HEX SOCKET • 1/2" WRENCH • 5/16" NUT DRIVER • 3/8" NUT DRIVER

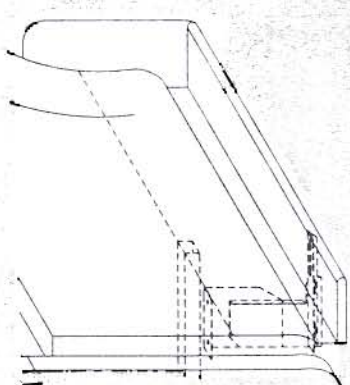

BOX BRACKET LOCATION (DRIVERS SIDE SHOWN)

1 LOCATE THE FIRST BED CROSS BRACE BEHIND THE CAB

2 BRACKET ASSEMBLY ASSEMBLE WITH 5/16" BOLTS

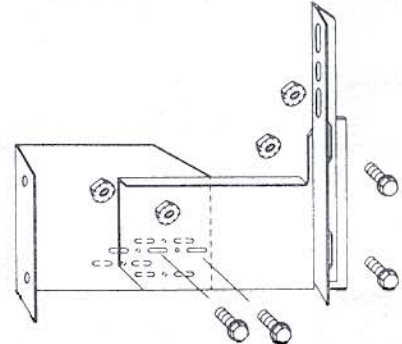

3

PREDRILL A 5/16" HOLE NEAR THE END OF THE CROSSBRACE. SLIDE NUT CUP INTO END OF CROSS BRACE AT BRACKET LOCATION. BRACKET ASSEMBLY MOUNT TO BED ASSEMBLE WITH 5/16" BOLTS AND NUT CUP AND #14 SELF DRILLING SCREW

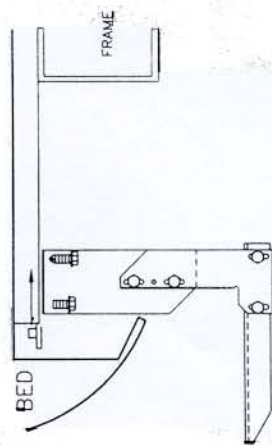

MOUNT AT LOCATION SHOWN AT 1

4 BEND STONE GUARD BY HAND AND KNEE TO FIT THE WHEEL WELL BEFORE INSTALLING TO RUNNING BOARD



5 FASTEN REAR STONE GUARD TO BOARDS WITH 3/8" SELF TAPPING BOLT. BEND STONE GUARD BY HAND AND KNEE TO FIT THE WHEEL WELL.

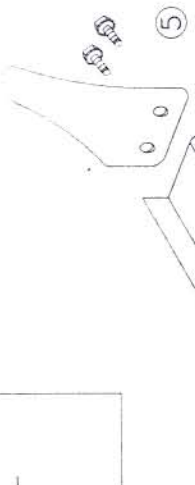

6 SLIDE ONE 1/4" x 5/8" SQUARE HEAD SCREW INTO EACH TRACK.

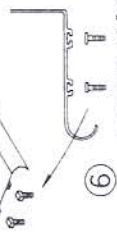

7 INSTALL END CAP TO BOARD WITH 3/8" SELF TAPPING BOLT



8 HOLD BOARD IN PLACE, WITH THE FRONT RESTING ON THE BOX BRACKET. BE SURE THAT 1/4" BOLTS ARE PLACED INTO THE BRACKET STEP SUPPORT.

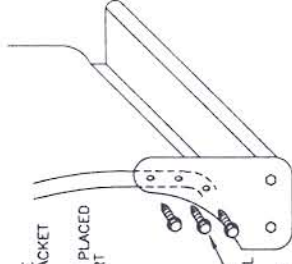

9 SCREW THROUGH STONE GUARD INTO FENDERWELL LIP USING #14 BY 3/4 SHEET METAL SCREWS. MAKE SURE YOU DRILL INTO METAL. 3 PLACES AT EACH STONE GUARD

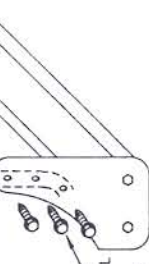

10 SECURE BOARD TO BRACKET WITH (2) 1/4" NUTS

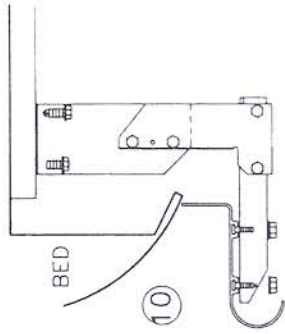

11

WITH BOARD LEVEL, TIGHTEN ALL LOOSE BOLTS

12

REPEAT FOR OTHER SIDE

NEWBOX
INCL 1/7/03
05/02/03